



OFFICE MODULES & SUSPENDED
LUMINAIRES

advanced systems



MONZA
TECHNICAL SPECIFICATION DATA

Strategic Lighting Group | Strategic Lighting (Europe) Limited | Narrow Lane End Works, 64 Worple Road, Epsom, Surrey KT18 7AG | England UK
Tel. +44 (0)845 241 4631 | Fax. +44 (0)845 241 4632 | Email. info@strategiclighting.com | www.strategiclighting.com



MONZA LED

LED - monochromatic circuit dimmable

IP20



Product Purpose & Meaning

- The Monza LED suspension uses individual louvre cells for each PowerLED. [Techno Micro-prismatic option also].
- The name "Monza" [Monn-Za] is synonymous for power with control.

Product Summary

- Direct office suspended luminaire with twin-blade profile with optional bladed louvre or techno-prismatic diffuser.
- Leading high output 3W PowerLED array - 6500K.
- Ultra-slimline 27mm profile height.
- Dimmable with all digital signal protocols.
- Remote emergency versions - 3 hour maintained.

Applications

- Main & ancillary offices, meeting rooms and cellular office desking.
- Schools, libraries, conference suites.
- Ideal for showrooms and retail.

LED Performance

Lamp Type	3W 800mA PowerLED - Philips Lumiled
Lamp Qty	16 or 32 LED array
Lamp Source	Philips Lumiled
Lumen Output	55lm/w
Lamp CRI	> 80 [6000K]
Life	typically 50,000hrs
Optic Beams	Refer to Polar Curve and Photometric files.

Electrical Data

Voltage	230Vac mains
Load Watts	Variable
Cable Terminal	Yes
Gear	Driver integrated in Ceiling Support can be remote to 30 metres.
Configuration	Mains Power
Dimming	Yes
Data Protocol(s)	DALI, DSI digital or 0-10V analogue

Description

Monza is a slimline architectural stylised suspended direct luminaire with twin blade profile. Available in dedicated LED technology with parabolic louvre cell option or techno-prismatic diffuser. Utilising the latest high output 3W PowerLED's from Philips Lumiled for added confidence and extra durability. Made for modern fine-wire suspension and minimalistic interior design aesthetics. Benefits extra-long LED life and 21st Century energy-sustainability for offices which embrace today for all our futures.

Construction & Finishes

Extruded aluminium body with reflector/louvre in sheet pressed aluminium or with techno-prismatic diffuser. Standard finish in powdercoat painted RAL9006 aluminium. Custom options on request.

Main Features

- LED lifetime 50,000hrs.
- Fluxdrive™ techno-prismatic [option in PC to Tpa >850°C.]
- Designer ultra-slimline 27mm 'blade' aesthetic.
- Discreet fine-wire suspension.

Mounting

- Fine-wire suspension kit to 0.8 metres c/w tool-free easy adjustability tension system.
- c/w ceiling power outlet.
- Integral gear

- 3 Core Connectors Live & Neutral power feeds - with functional Earth.

Connection Diagram A

- Connection is for standard main voltage with gear & terminals in the ceiling mount plate.
- See Connection Diagram A - Page 324.

LED Colour Consistency :
1 MacAdam Ellipse - 100K



Energy Saving Technology



Green Energy Technology



Lamp Type Technology



Wattage - Unit
32 x 3W dimmable



Voltage
ac - alternating current only



Integral HF Ballast



Lumens / Watt
value - based on 3W - 6000K inc losses



CRI - Group Index
value - >70%



IP Rating
Standard Interior Only



Insulation Class
- Functional Earth Required



Product Weight
Kilograms/unit



ENEC compliance



CE mark



F - mark
fire safe rating



Environmental Technology

LED DEDICATION



MONZA LED

LED - monochromatic circuit dimmable

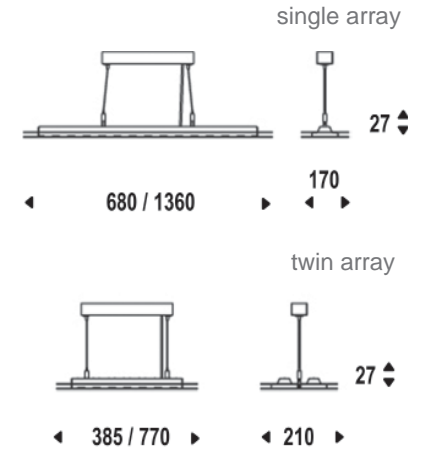

Product Codes :

Louvre Controller



Single LED Array

Version with single LED array, each LED contained in its own louvre blade for ultimate glare control.

MON.116.LO	W 130 x L 680mm	16 x 3W LED - 2650lms	Parabolic Louvre
MON.132.LO	W 130 x L 1360mm	32 x 3W LED - 5300lms	Parabolic Louvre



Twin LED Array

Version with twin LED array, each LED contained in its own louvre blade for ultimate glare control.

MON.216.LO	W 210 x L 770mm	2x16x3W LED - 5300lms	Parabolic Louvre
------------	-----------------	-----------------------	------------------

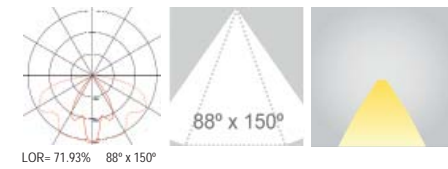

Techno-Prismatic Diffuser



Single LED Array

Version with single LED array, LED array behind a linear techno-prismatic diffuser for high output.

MON.116.TP	W 130 x L 680mm	16 x 3W LED - 2650lms	Techno-prismatic
MON.132.TP	W 130 x L 1360mm	32 x 3W LED - 5300lms	Techno-prismatic



Twin LED Array

Version with twin LED array, LED array behind a linear techno-prismatic diffuser for high output.

MON.216.TP	W 210 x L 770mm	2x16x 3WLED - 5300lms	Techno-prismatic
------------	-----------------	-----------------------	------------------

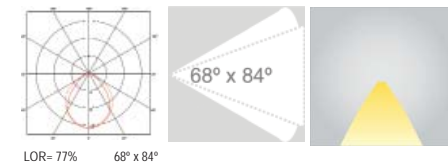

photometric data:
consult sales department for latest LED's up to date outputs.

POST-FIX CODES

For codes with
DIMMING - For dimming by DALI ,DSI or 1-10V please add post-fix "-DALI", "-DSI" or "-1-10V" respectively.
EMERGENCY - integrated emergency is not possible - remote gear is possible please add post-fix "-REm3".
TPa>850°C Prismatic - For use of high thermal prismatic please add post-fix "TPA".
important note: beam angles and lumen outputs are approximate and guide only
please refer to full photometric data, lamp manufacturers data or consult technical dept.

OFFICE MODULES SUSPENDED & SYSTEMS

product pages start page 27

office - retail - leisure

OFFICE MODULES SUSPENDED & SYSTEMS

office - retail - leisure

product pages start page 27

6

7

RECESSED MODULES

T5 - 2x54W Page 28
1200x300



techno-micro-prismatics



OFFICIO series

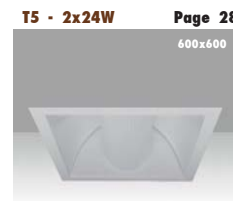

OFFICIO series



OFFICIO series

Page 30



RETAIL STORE



LED - 65W Page 34
600x600

PERSCARA RX



T5 - 2x24W Page 32
600x600

GIOTTO XS series



T5 - 2x24W Page 32
600x600

GIOTTO XS series



T5 - 2x24W Page 32
600x600

GIOTTO XS series

SUSPENDED SYSTEM

SYSTEM Page 57



XICATA 48 series - T5

SYSTEM Page 57/61



XICATA 48 - T5 & SPOTS

SYSTEM Page 61



XICATA 48 series - SPOTS

SYSTEM Page 65

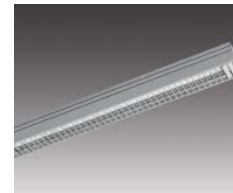

XICATA 48 - SINGLE T5

SYSTEM Page 67



XICATA 48 - ROTATOR 1

SYSTEM Page 71



XICATA 48 - WALL UNITS

SYSTEM Page 69



XICATA 48 - VIENNA

SYSTEM Page 69



XICATA 48 - TUBE

SYSTEM Page 69



XICATA 48 - LED SPOTS

SYSTEM Page 67



XICATA 48 - ROTATOR 2

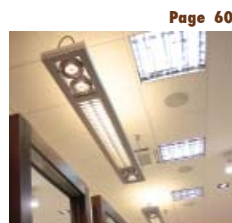

Page 60

HAIR SALONS



Page 64

LIBRARY'S



Page 66

CAR DEALERSHIPS

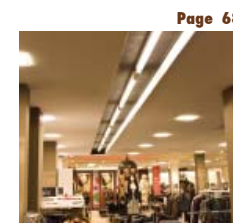

Page 68

RETAIL



Page 63

SCHOOLS

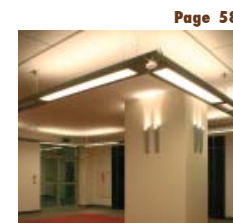

Page 58

RECEPTIONS

SUSPENDED LUMINAIRES

Page 36 30x3W - LED



MONZA

Page 38 3x54W - T5



VERONA

Page 40 3x80W - T5



AILERON

Page 42 LED - 32x3W



CHIARO

Page 44 LED - 32x3W



LATLUCE

Page 46 2x54W - T5



MILANO series

Page 46 2x54W - T5



MILANO series

Page 48 2x24W - T5



VIENNA

Page 35 LED - 72W

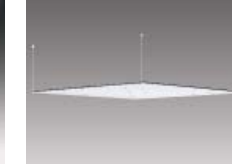

PERSCARA XS

Page 103 LED - 20W/m



AMBIENTALE

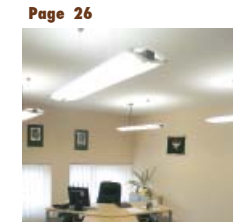

Page 26 OFFICE'S

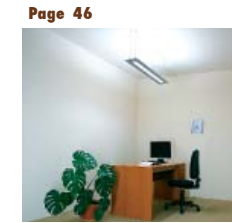

Page 46 OFFICE'S



Page 39 OFFICE'S

SURFACE

Page 48 2x80W - T5



VIENNA

Page 48



OFFICE'S

RECESSED SYSTEM

Page 50 SYSTEM



XICATA 77 RECESSED

Page 51 SYSTEM



XICATA 77 RECESSED

Page 54



OFFICE'S

OFFICE WALL LUMINAIRES

Page 228 2x55W TC-1



ASYAERO

Page 229 1x55W TC-1



KEELIO

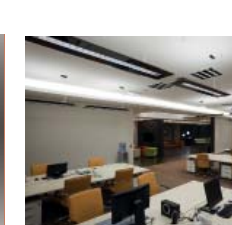

DEALER ROOMS